

### KEY FEATURES

- Power Module for PCB Mountable
- 2:1 Input Range
- Low Ripple and Noise
- Regulated Output
- Synchronous-rectifier Topologies
- Vout Trim and ON/OFF Control Function
- 2-Years Product Warranty



### ELECTRICAL SPECIFICATIONS

Model No. ( Single Output )	SU40-12-5S	SU40-12-12S	SU40-12-15S	SU40-12-24S
Max Output Wattage (W)	40W	40W	40W	40W
Input Voltage (V.DC.)	12V (9-18V)	12V (9-18V)	12V (9-18V)	12V (9-18V)
Output Voltage (V.DC.)	5V / 8000mA	12V / 3333mA	15V / 2666mA	24V / 1666mA
Efficiency	85%	85%	85%	85%

Model No. ( Single Output )	SU40-24-5S	SU40-24-12S	SU40-24-15S	SU40-24-24S
Max Output Wattage (W)	40W	40W	40W	40W
Input Voltage (V.DC.)	24V (18-36V)	24V (18-36V)	24V (18-36V)	24V (18-36V)
Output Voltage (V.DC.)	5V / 8000mA	12V / 3333mA	15V / 2666mA	24V / 1666mA
Efficiency	87%	86%	86%	86%

Model No. ( Single Output )	SU40-48-1.8S	SU40-48-2.5S	SU40-48-3.3S	SU40-48-5S	SU40-48-12S	SU40-48-15S	SU40-48-24S
Max Output Wattage (W)	14.4W	20W	26.4W	40W	40W	40W	40W
Input Voltage (V.DC.)	48V (36-75V)	48V (36-75V)	48V (36-75V)	48V (36-75V)	48V (36-75V)	48V (36-75V)	48V (36-75V)
Output Voltage (V.DC.)	1.8V / 8000mA	2.5V / 8000mA	3.3V / 8000mA	5V / 8000mA	12V / 3333mA	15V / 2666mA	24V / 1666mA
Efficiency	76%	82%	84%	88%	87%	87%	87%

Model No. ( Single Output )	SU40-48-1.8S	SU40-48-2.5S	SU40-48-3.3S	SU40-12-5S SU40-24-5S SU40-48-5S	SU40-12-12S SU40-24-12S SU40-48-12S	SU40-12-15S SU40-24-15S SU40-48-15S	SU40-12-24S SU40-24-24S SU40-48-24S	
Max Output Wattage (W)	14.4W	20W	26.4W	40W	40W	40W	40W	
Input	Input Filter: $\pi$ type							
Output	Input Voltage (V.DC.)	1.8	2.5	3.3	5	12	15	24
	Voltage Accuracy	$\pm 2\%$						
	Current (mA) max	8000	8000	8000	8000	3333	2666	1666
	Minimum Load	0%						
	Line Regulation(LL-HL) (typ)	$\pm 0.5\%$						
	Load Regulation (10-100%) (typ)	$\pm 1\%$						
	Ripple	50 mV max.				$\pm 1\%$ max.		
	Noise	100 mV max.				$\pm 1\%$ max.		
	Trim	$\pm 10\%$						
Protection	Switching Frequency	5V Output: 250KHz		12V Input: 200KHz	others: 400KHz			
	Over power Protection	Works over 120% of rating and recovers automatically.						
	Over voltage Protection	Zener diode clamp						
Isolation	Short Circuit Protection	Hiccup mode, auto-recovery						
	Voltage	1600 VDC.						
	Resistance	$10^8$ ohms						
Environment	Capacitance	1000 pF						
	Operating Temperature	-25°C...+70°C (with derating)						
	Storage Temperature	-55°C...+105°C						
	Case Temperature	+100°C max.						
	Temperature Coefficient	$\pm 0.02\%$ Per°C						
	Humidity	95% RH						
Physical	MTBF	>550,000 h @ 25°C (MIL-HDBK-217F)						
	Dimension (L x W x H)	2.0 x 2.0 x 0.45 Inches ( 50.8 x 50.8 x 11.4 mm ) Tolerance $\pm 0.5$ mm						
	Case Material	Nickel-Coated Copper with Non-Conductive Base, Six-side shielded.						
	Weight	70 g						
Cooling Method	Free-air convection							

All specifications valid at nominal input voltage, full load and +25°C after warm-up time unless otherwise stated.

### ELECTRICAL SPECIFICATIONS

Model No. ( Dual - Triple Output )	SU40-12-5D	SU40-12-12D	SU40-12-15D	SU40-12-5S12D	SU40-12-5S15D
Input Voltage (V.DC.)	12V (9-18V)	12V (9-18V)	12V (9-18V)	12V (9-18V)	12V (9-18V)
Output Voltage (V.DC.)	±5V / ±3500mA	±12V / ±1666mA	±15V / ±1320mA	5/±12V / 5000/±600mA	5/±15V / 5000/±500mA
Efficiency	82%	85%	85%	85%	85%

Model No. ( Dual - Triple Output )	SU40-24-5D	SU40-24-12D	SU40-24-15D	SU40-24-5S12D	SU40-24-5S15D
Input Voltage (V.DC.)	24V (18-36V)	24V (18-36V)	24V (18-36V)	24V (18-36V)	24V (18-36V)
Output Voltage (V.DC.)	±5V / ±3500mA	±12V / ±1666mA	±15V / ±1320mA	5/±12V / 5000/±600mA	5/±15V / 5000/±500mA
Efficiency	83%	86%	86%	86%	86%

Model No. ( Dual - Triple Output )	SU40-48-5D	SU40-48-12D	SU40-48-15D	SU40-48-5S12D	SU40-48-5S15D
Input Voltage (V.DC.)	48V (36-75V)	48V (36-75V)	48V (36-75V)	48V (36-75V)	48V (36-75V)
Output Voltage (V.DC.)	±5V / ±3500mA	±12V / ±1666mA	±15V / ±1320mA	5/±12V / 5000/±600mA	5/±15V / 5000/±500mA
Efficiency	84%	87%	87%	87%	87%

Model No. ( Dual - Triple Output )	SU40-12-5D SU40-24-5D SU40-48-5D	SU40-12-12D SU40-24-12D SU40-48-12D	SU40-12-15D SU40-24-15D SU40-48-15D	SU40-12-5S12D SU40-24-5S12D SU40-48-5S12D	SU40-12-5S15D SU40-24-5S15D SU40-48-5S15D	
Max Output Wattage (W)	35W	40W	40W	40W	40W	
Input	Input Filter: $\pi$ type					
Output	Voltage (V.DC.)	±5	±12	±15	5/±12, 5/±15	
	Voltage Accuracy	±2%				
	Current (mA) max	±3500	±1666	±1320	5000/±600	5000 / ±500
	Minimum Load	0%			10%	
	Line Regulation (LL-HL) (typ.)	±0.5%			±1% / ±5%	
	Load Regulation (10-100%) (typ.)	±2%			±3% / ±5%	
	Load Cross Regulation (25%) (typ.)	Triple(main): ±2% Triple(auxiliary): ±5%				
	Ripple	<0.2% Vout +20mV max (Vp-p)				
	Noise	<0.5% Vout +50mV max (Vp-p)				
	Trim	±10%			None	
Switching Frequency	5V Output: 250KHz		12V Input: 200KHz	others: 400KHz		
Protection	Over Power Protection	Works over 120% of rating and recovers automatically.				
	Over Voltage Protection	Zener diode clamp				
	Short Circuit Protection	Hiccup, auto-recovery				
Isolation	Voltage	1600 VDC.				
	Resistance	10 <sup>8</sup> ohms				
	Capacitance	1000 pF				
Environment	Operating Temperature	-25°C...+70°C (with derating)				
	Storage Temperature	-55°C...+105°C				
	Case Temperature	+100°C max.				
	Temperature Coefficient	±0.02% Per°C				
	Humidity	95% RH				
	MTBF	>550,000 h @ 25°C (MIL-HDBK-217E)				
Physical	Dimension (L x W x H)	2.0 x 2.0 x 0.45 Inches ( 50.8 x 50.8 x 11.4 mm ) Tolerance ±0.5 mm				
	Case Material	Nickel-Coated Copper with Non-Conductive Base, Six-side shielded.				
	Weight	70 g				
	Cooling Method	Free-air convection				
Safety	Agency Approvals: CE (Pending)					
EMC	EMI (Conducted & Radiated Emission): EN 55022 class A					

All specifications valid at nominal input voltage, full load and +25°C after warm-up time unless otherwise stated.

### OUTPUT NOISE

The output noise is measured with 10 $\mu$ F tantalum capacitor and 0.1 $\mu$ F ceramic capacitor across output.

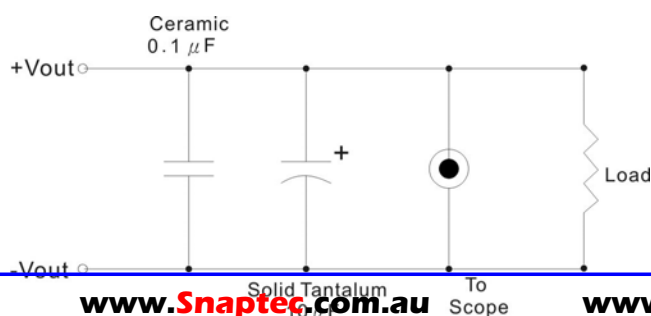

## MECHANICAL DIMENSION ( Top View )

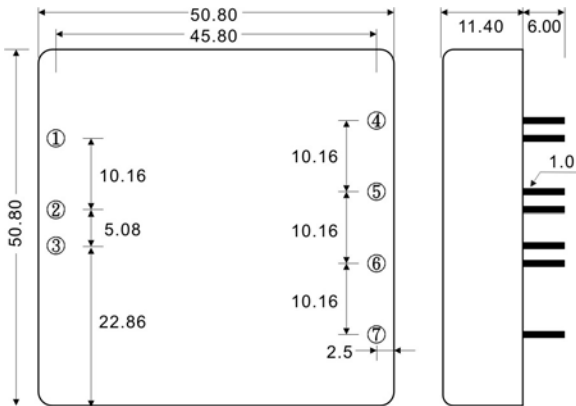

PIN#	Single	Dual	Triple
1	ON / OFF	ON / OFF	ON / OFF
2	-VIN	-VIN	-VIN
3	+VIN	+VIN	+VIN
4	TRIM	TRIM	-VOUT
5	-VOUT	-VOUT	COMMON
6	+VOUT	COMMON	+5V OUT
7	NC	+VOUT	+VOUT

## BLOCK DIAGRAM

Output Voltage (V.DC) : 1.8, 2.5V, 3.3V, 5V

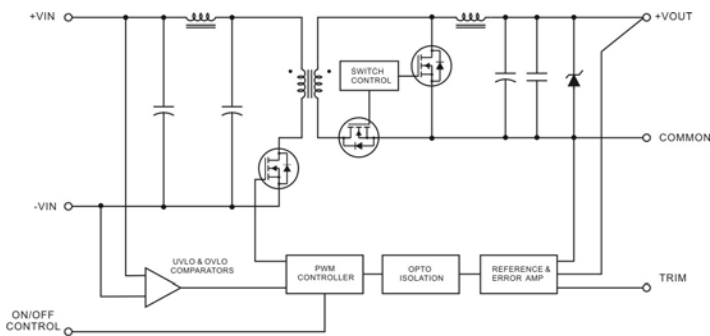

Output Voltage (V.DC) : 12V, 15V, 24V

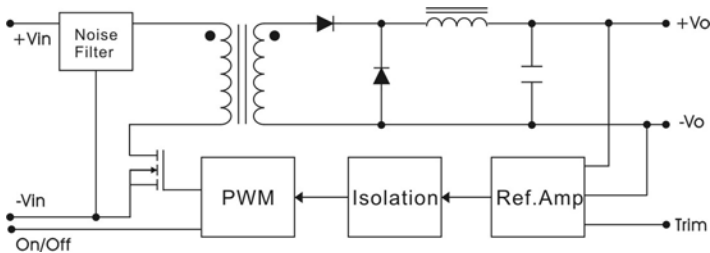

## DERATING

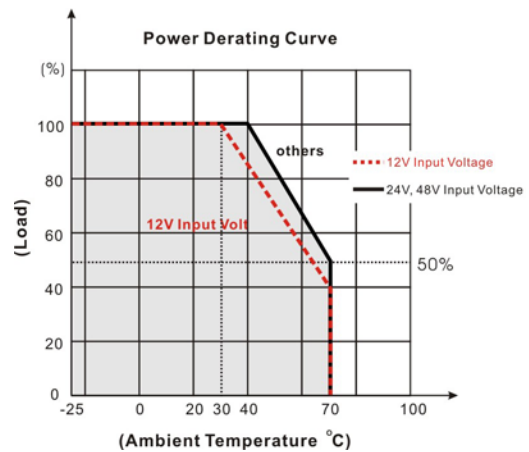

## REMOTE

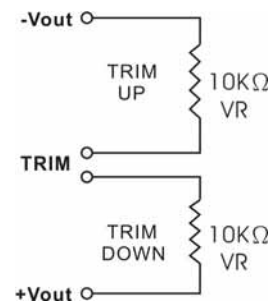

## Dual Output

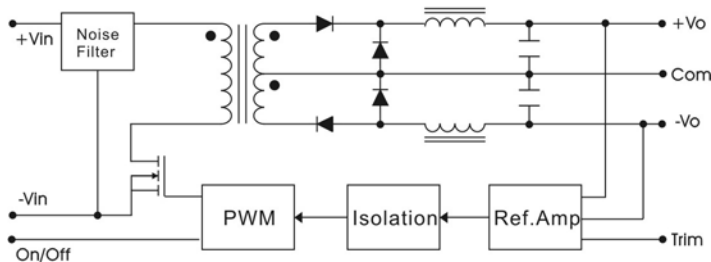

## Triple Output

